

Digital Temperature Controller

# BR6

## INSTRUCTION MANUAL

Thank you for purchasing HANYOUNG product.  
Please check whether the product is the exactly same as you ordered.  
Before using the product, please read this instruction manual carefully.  
Please keep this manual where you can view at any time

HANYOUNGNUX CO.,LTD  
28, Gilpa-ro 71beon-gil, Nam-gu, Incheon, Korea  
TEL : (82-32)876-4697 FAX : (82-32)876-4696  
http://www.hynux.com

HEAD OFFICE



### Safety information

Before using the product, please read the safety information thoroughly and use it properly. Alerts declared in the manual are classified to Danger, Warning and Caution by their criticality

	<b>DANGER</b>	DANGER indicates an imminently hazardous situation which, if not avoided, will result in death or serious injury
	<b>WARNING</b>	WARNING indicates a potentially hazardous situation which, if not avoided, could result in death or serious injury
	<b>CAUTION</b>	CAUTION indicates a potentially hazardous situation which, if not avoided, may result in minor or moderate injury

**DANGER**  
Do not touch or contact the input/output terminals because it may cause electric shock.

- WARNING**
- If the user use the product with methods other than specified by the manufacturer, there may be bodily injuries or property damages.
  - If there is a possibility of an accident caused by errors or malfunctions of this product, install external protection circuit to prevent the accident.
  - To prevent deflection or malfunction of this product, apply a proper power voltage in accordance with the rating.
  - Since this product is not designed with explosion-protective structure, do not use it any place with flammable or explosive gas.
  - Reassemble this product while the power is OFF. Otherwise, it may be a cause of malfunction or electric shock.
  - There is a possibility of occurring electric shock so please use this product after installing it to a panel while it is operating.

- CAUTION**
- The contents of the instruction manual are subjective to change without prior notice.
  - Please make sure that the product is not damaged during shipping.
  - Please use this product in a place where there is no direct vibration and a large physical impact to the product.
  - Please use this product in a place where there is no water, oil, chemicals, steam, dust, salt, iron or others.
  - Please avoid places where excessive amounts of inductive interference and electrostatic and magnetic noise occur.
  - Display's text cannot be seen due to the light of the sun outside or the bright lightning inside.
  - For thermocouple (TC) input, please use a prescribed compensation lead wire. (There is a temperature error if a general lead is used.)
  - If there is a lot of noise from the power line, installing an insulated transformer or a noise filter is recommended. The noise filter should be grounded on the panel and the lead wire between the output of the noise filter and the power terminal of the instrument should be as short as possible.
  - Please use a switch or breaker (IEC60947-1 or IEC60947-3 approved) when the product is mounted on a panel.
  - The warranty of this product (including accessories) is 1 year only when it is used for the purpose it was intended under normal condition.
  - When the power is being supplied there should be a preparation time for the contact output. Please use a delay relay together when it is used as a signal on the outside of interlock circuit or others.
  - Before using a temperature controller, there could be a temperature difference between PV of the temperature controller and the actual temperature so please operate the temperature controller after correcting the temperature difference appropriately.

### Suffix code

Model	Code	Description
BR6 -	<input type="checkbox"/> <input type="checkbox"/> <input type="checkbox"/> <input type="checkbox"/>	Digital temperature controller 72(W) mm × 35(H) mm
Control type	F	ON / OFF control, Proportional control (Parameter setting)
Input	N	Company exclusive sensor (TH-540N) ※ Thermistor
Control output	M	Relay
	S	SSR (voltage pulse output 5 V DC)
Power supply voltage	P3	10 - 24 V DC/AC 50 - 60 Hz
	P4	100 - 240 V AC 50 - 60 Hz

### Specification

Power consumption	5 VA max (220 V AC 60 Hz)	
Input sensor	Company exclusive sensor (TH-540N) ※ Thermistor (NTC)	
Display accuracy	±1 % of FS ±1 Digit	
Control output (main output)	Relay output	Contact composition : S.P.D.T, 250 V AC, 5 A (resistive load)
Alarm/Defrost	SSR	Approx 5 V DC (resistive load min 500 Ω) approx 50 mA max
Control action	Relay	Contact composition : 1 c, 250 V AC, 5 A (resistive load)
Setting method	Reverse action(heating) or direct action(cooling)	
Other function	Digital method by up and down key	
Ambient temperature	Deforsting Timer, Alarm function, Heating/cooling control	
Resistance between wires	0 °C ~ 50 °C	
Ambient humidity	Below 10 Ω for each wire	
	35 ~ 85 % RH (with no condenssation)	

### Dimension and panel cutout

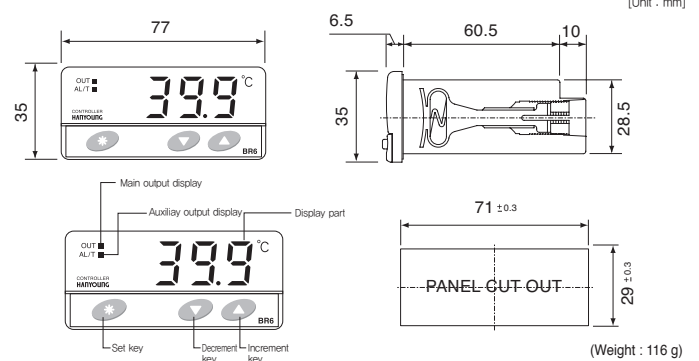

### SENSOR (NTC)

UThis sensor is only for the BR6

Name	Sensory type	Range(°C)	Accuracy	Remark
TH540N	Thermistor	-40.0 ~ 90.0	±1.5 °C	When you use diode sensor, max ±3.5 °C temperature deviation may be happen (±1.5 °C Sensor deviation & ±2 °C controller deviation)

\* Extension of sensor length or modification of sensor will be cause of malfunction.

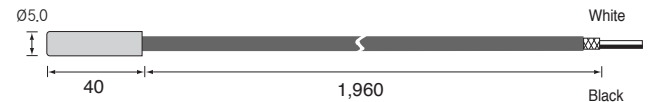

### Connection

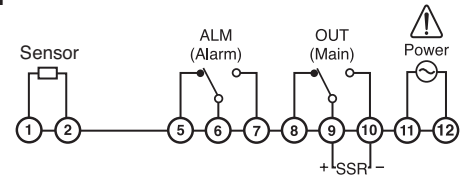

### Control method for temperature

#### Heating / Cooling Control Selection

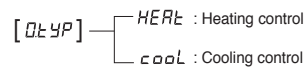

#### Cooling control (ON/OFF)

PV > SV → Main output relay "ON" / PV < SV → Main output relay "OFF"

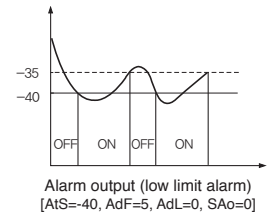
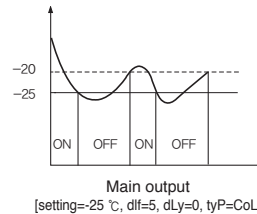

#### Heating Control (ON/OFF)

PV > SV → Main output relay "OFF" / PV < SV → Main output relay "ON"

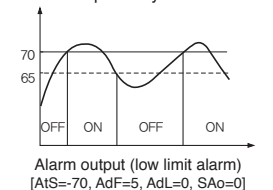
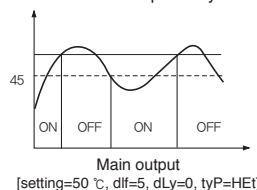

### Proportional control

Manipulated variable (output size) of set value operates by proportioning to deviation and this is known as proportional control. Also variation range of manipulated variable from 0 ~ 100 % is known as the proportional band. Therefore, when proportional band is less than the current temperature, the manipulated variable becomes 100 % and when PB is more than the current temperature, the manipulated variable becomes 0 % and when set value and current temperature becomes same, the manipulated variable becomes 50 %.

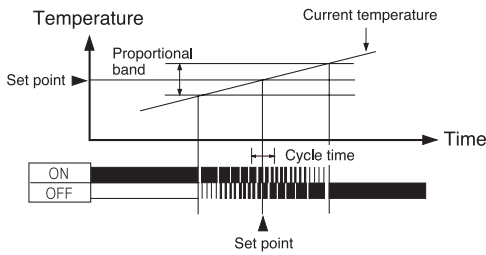

### Delay timer set

Press **☉** Key continuously for 3sec. And then, press **☉** Key until getting "2dLY". Change a set point by **▲** / **▼** Key, and preservation it by **☉** Key [0tLYP] → [1dLYF] → [2dLY] (0 ~ 240 sec.)

#### Operating description by delay-timer

- Delay time dLY = 0
- Delay time dLY = 5

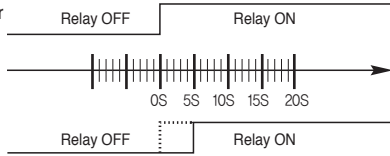

※ In case of Delay Time=0, Relay is immediately ON when output signal is generating. In case of delay time=5, Relay is ON after 5 sec. when output signal is generating. In the interval of 5 sec, the output indicator is flickering during delay timer operation. After the delay time, the output indicator lights as the relay is on.

### Auxiliary output(Timer-mode) set and operating description

It is possible to use timer-mode as defrosting function in case of freezer.

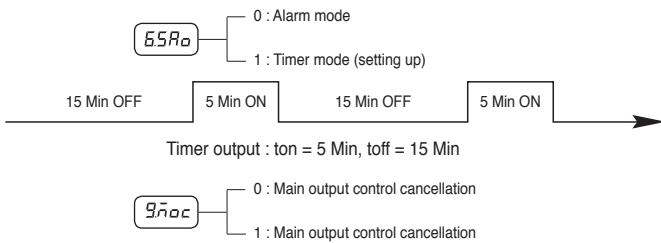

When using MOC '1', main output will be OFF automatically as timer is ON. If using MOC function, you can effectively use timer output as a defrosting function.

## Setting up menu

### Set Value lock function and decimal function

Function	SV	Description
Lock	0	Cancellation of lock function
	1	Operation of lock function
trSL	0	Decimal point 0.1 °C
	1	No decimal point 1 °C
Time	0	"sec." setting in Timer (0 ~ 3,600 sec)
	1	"min." setting in Timer (0 ~ 3,600 min)
PorF	0	P.I.D control (P.B value/M.R value setting isavailable)
	1	ON / OFF control

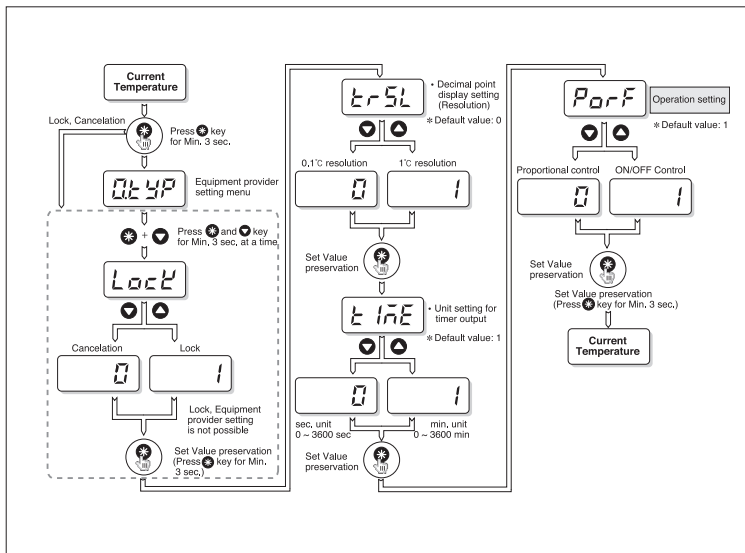

### Set mode for normal users

#### F control (ProF:1) : ON/OFF control

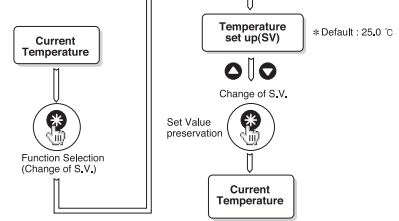

#### P control (ProF:0) : P.I.D control

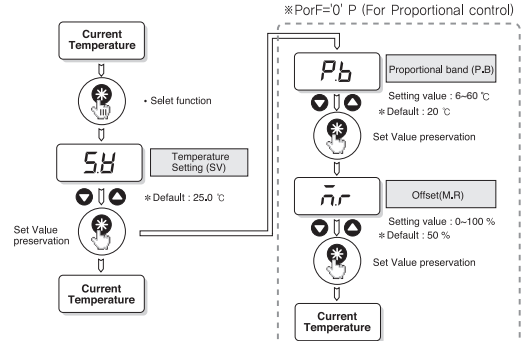

### Set mode for equipment provider

